

ROLLING GRILLES

VISIONAIRE[®] MICROCOIL[®] GRILLE

Models ESG10C & ESG12C

MEASURE THE WIDTH AND HEIGHT OF THE OPENING

DOOR SIZE AND AREA

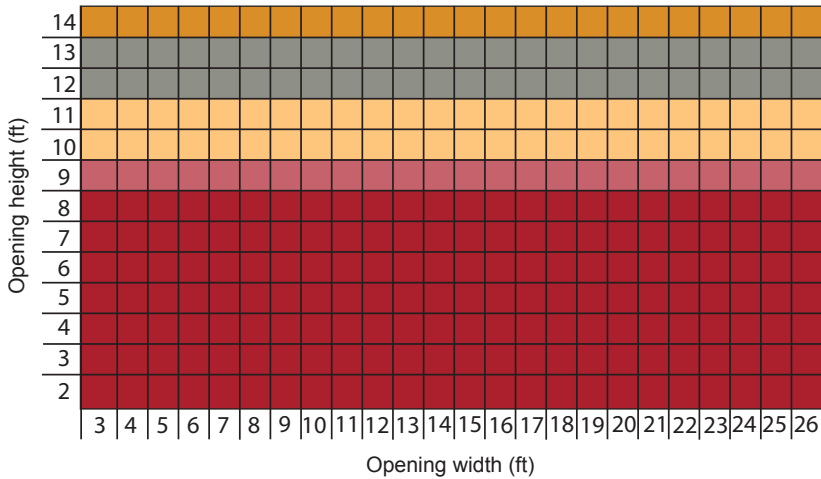

COMPONENT DIMENSIONS

	A	B	C	D	E
	10 1/2"	14 1/2"	FOW = 6" BJ = 6"	FOW = 6 1/2" BJ = 6 1/2"	5"
	10 3/4"	14 3/4"			
	11"	15"			
	11 1/2"	15 1/4"			
	11 3/4"	15 3/4"			

Dimensions provided are for stainless steel and aluminum curtains.

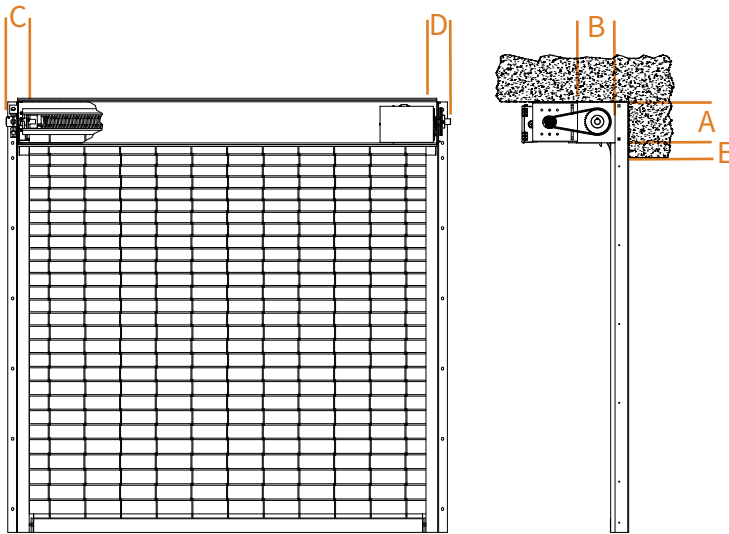

CURTAIN DESIGNS



Straight

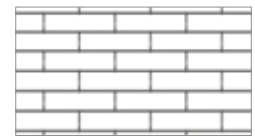

Brick

The dimensions featured on this sheet are provided as a rough guide for planning purposes. Exact dimensions cannot be provided until field conditions and all options are confirmed. Once field conditions are confirmed, please visit our website at www.cornelliron.com/drawings to generate custom drawings on demand for your specific opening.

FACE OF WALL GUIDE CONSTRUCTION OPTIONS

STAINLESS STEEL

Z GUIDE

Typically used with masonry wall construction, guides are mounted to the interior or exterior side of the wall.

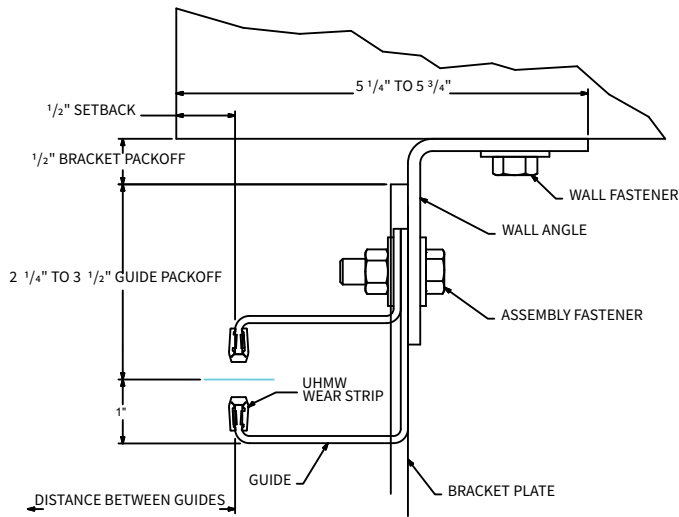

E GUIDE

Typically used with steel jambs, guides are mounted to the interior or exterior side of the wall.

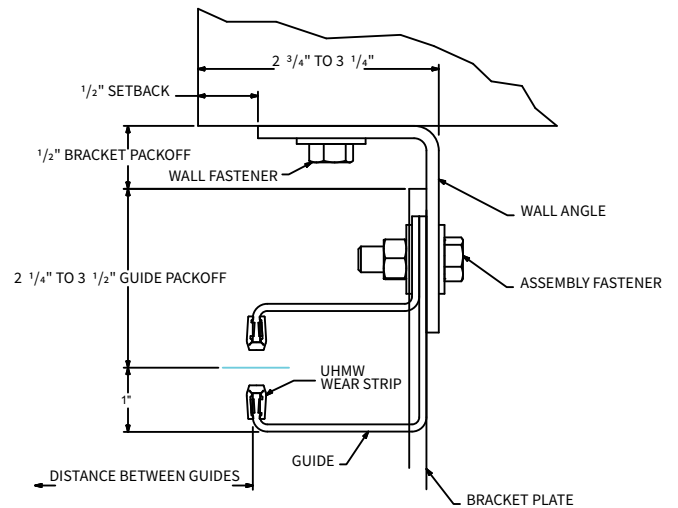

Z GUIDE TO TUBE

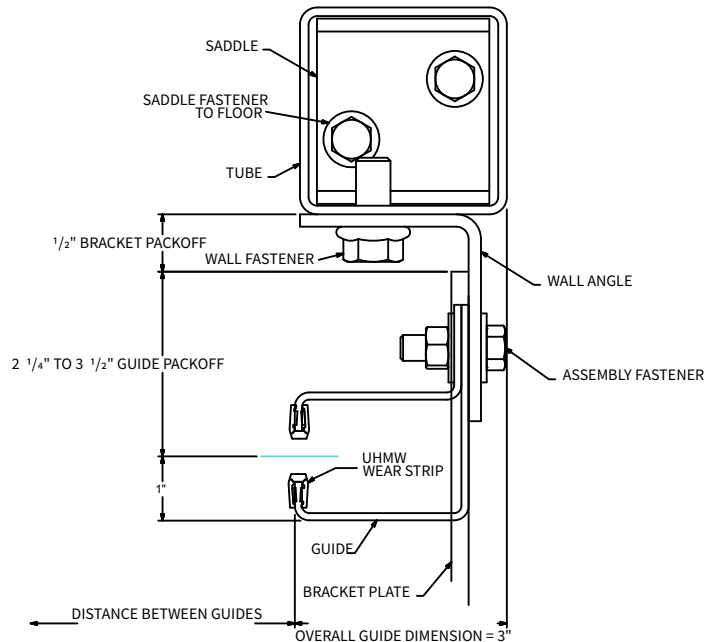
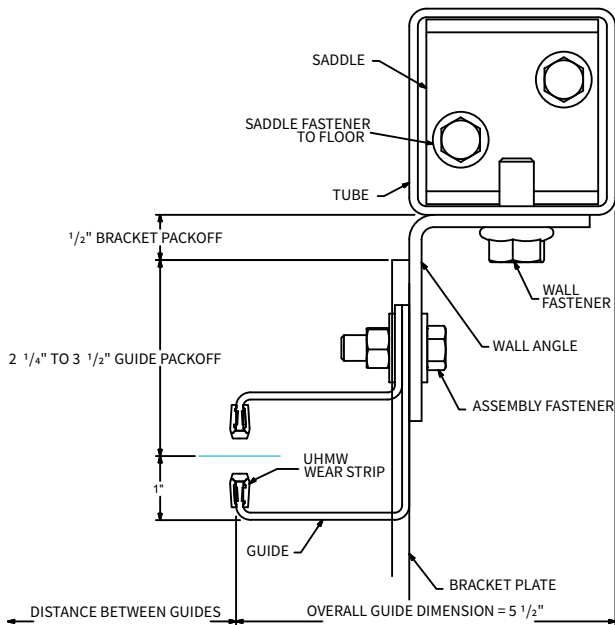

FACE OF WALL GUIDE CONSTRUCTION OPTIONS

ALUMINUM

Z GUIDE

Typically used with masonry wall construction, guides are mounted to the interior or exterior side of the wall.

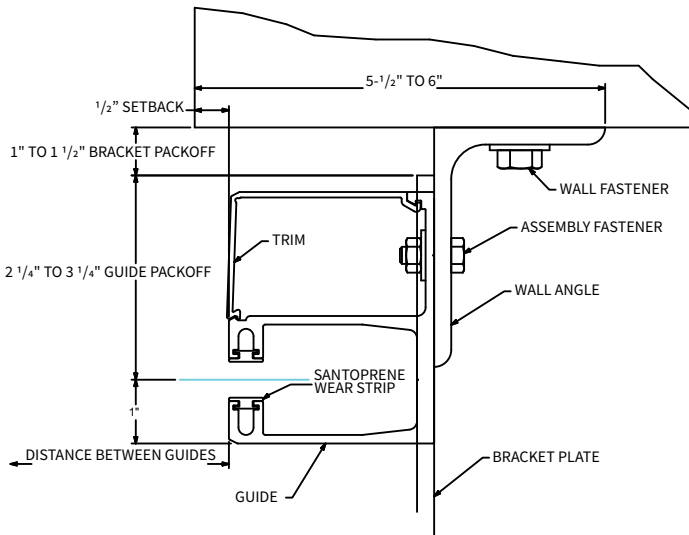

E GUIDE

Typically used with steel jambs, guides are mounted to the interior or exterior side of the wall.

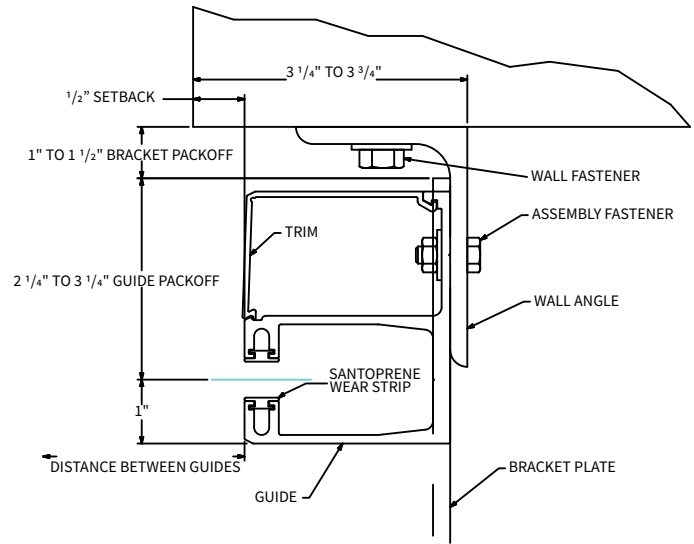

Z GUIDE TO TUBE

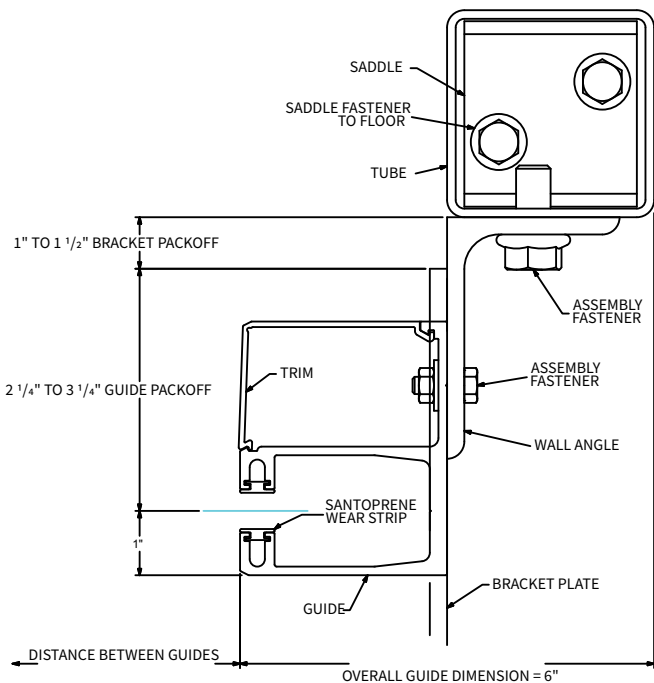

E GUIDE TO TUBE

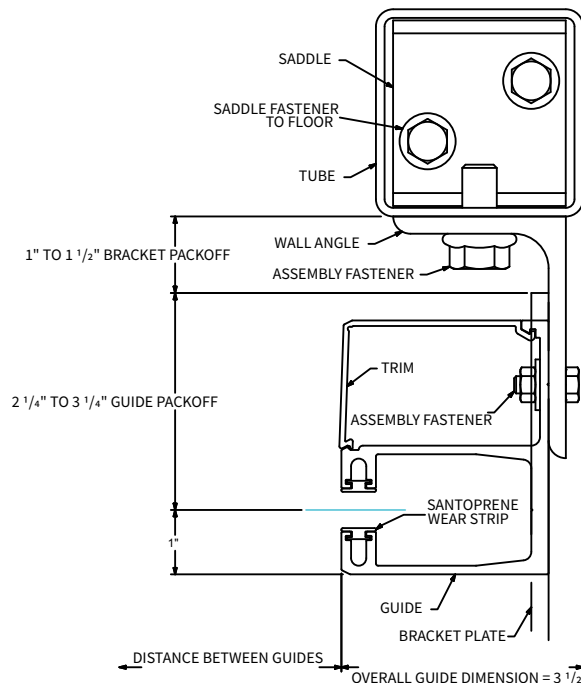

BETWEEN JAMBS GUIDE CONSTRUCTION OPTIONS

ALUMINUM

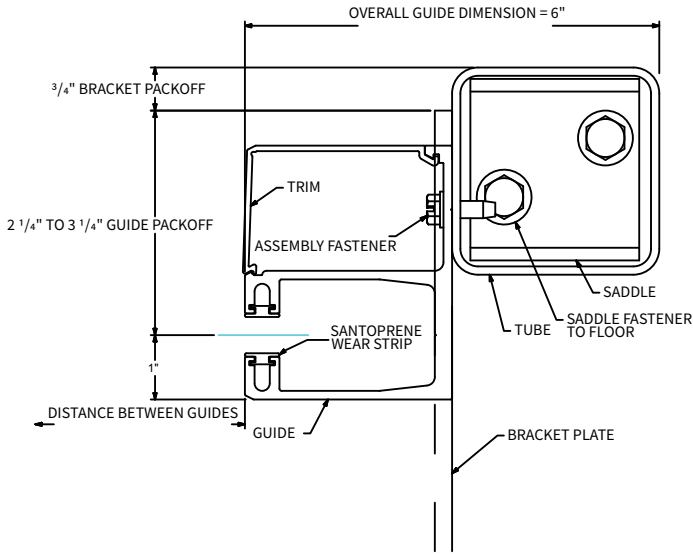

STAINLESS STEEL

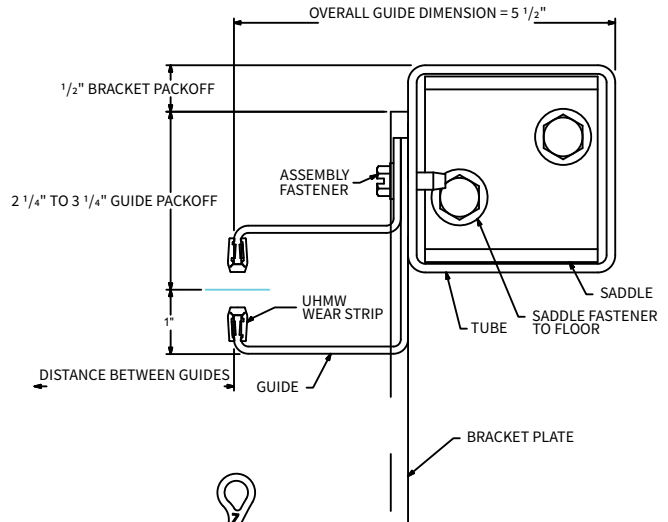

BOTTOM BAR CONSTRUCTION

Compact extruded aluminum in mill finish.

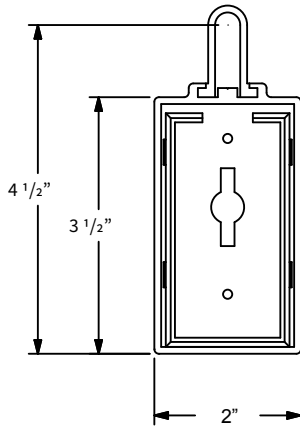

Curtain connection to bottom bar.

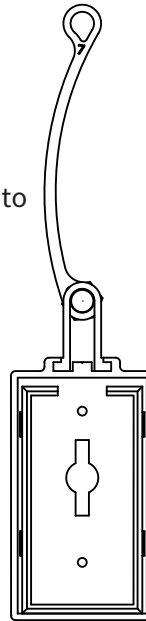

The dimensions featured on this sheet are provided as a rough guide for planning purposes. Exact dimensions cannot be provided until field conditions and all options are confirmed. Once field conditions are confirmed, please visit our website at www.cornelliron.com/drawings to generate custom drawings on demand for your specific opening.

CUSTOM-DESIGNED SOLUTIONS

Our experienced Architectural Design Support Team can customize our products to fit your specific application.

☎ 877.537.4567 ✉ arch@cornellcookson.com