

ROLLING COUNTER DOOR

ROLLING SHUTTER®

Model ESC10

MEASURE THE WIDTH AND HEIGHT OF THE OPENING

DOOR SIZE AND AREA

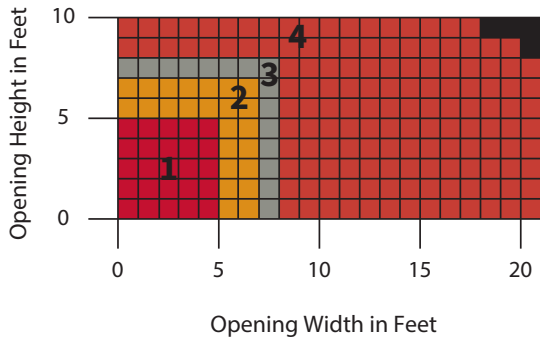

COMPONENT DIMENSIONS

Reference the zone number to view component dimensions for motorized doors.

Dimensions in Inches

1	11	11	3	5
2	11	11	3	5
3	12	12	3	5
4	13	13	3	5

Zone A B C D

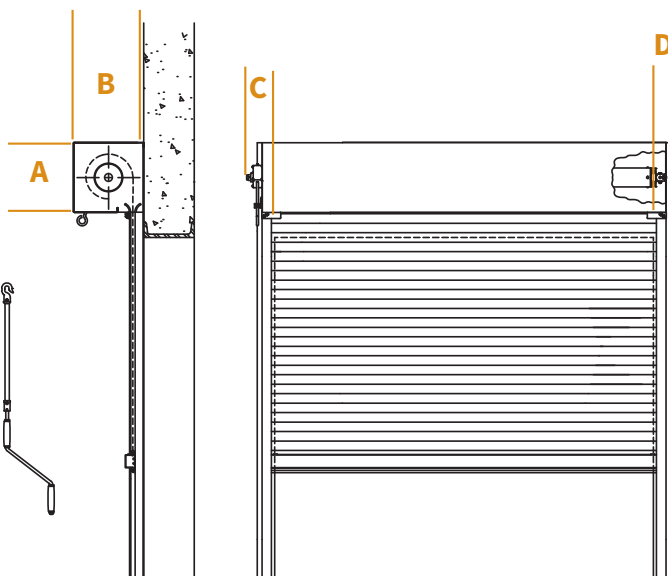

SLAT CROSS SECTION

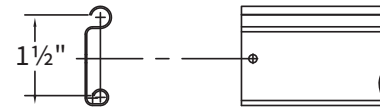

The dimensions featured on this sheet are provided as a guide. Please visit our website at www.cornelliron.com/drawings to generate drawings on demand with exact dimensions.

ROLLING COUNTER DOOR **ROLLING SHUTTER Model ESC10**

GUIDE CONSTRUCTION OPTIONS

EXTRUDED ALUMINUM

FACE OF WALL

Used most often, guides are mounted to the interior or exterior side of the wall.

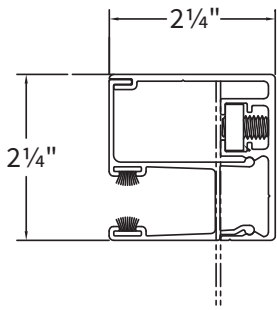

BETWEEN JAMB

Used when side clearance is minimal, guides are mounted to the inside of the jamb.

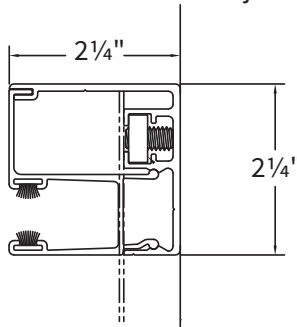

BETWEEN JAMBS WITH TUBES

Typically used if there's no wall support, and tubes and guides need to be recessed within the wall construction

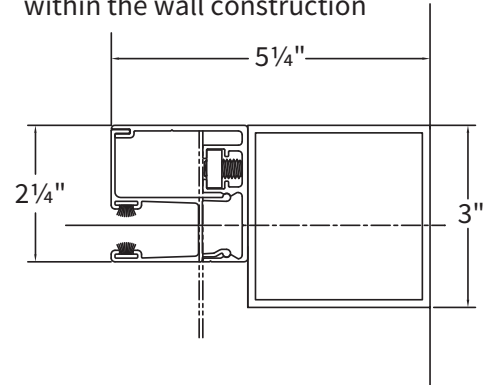

STEEL

FACE OF WALL

Used most often, guides are mounted to the interior or exterior side of the wall.

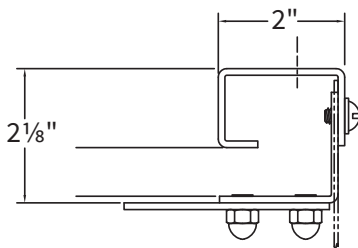

BETWEEN JAMB

Used when side clearance is minimal, guides are mounted to the inside of the jamb.

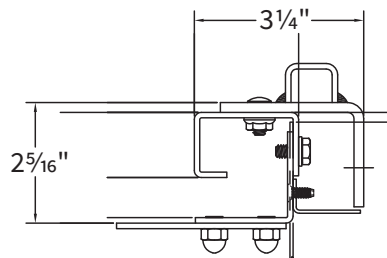

BETWEEN JAMBS WITH TUBES

Typically used if there's no wall support, and tubes and guides need to be recessed within the wall construction

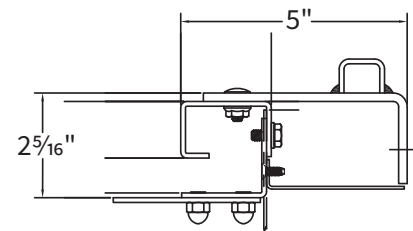

The dimensions featured on this sheet are provided as a guide. Please visit our website at www.cornelliron.com/drawings to generate drawings on demand with exact dimensions.

CUSTOM-DESIGNED SOLUTIONS

Our experienced Architectural Design Support Team can customize our products to fit your specific application. Call 800.233.8366 ext. 4551 • ads@cornelliron.com